

FX/FXH/FXL Series

DIN W72 × H72, W48 × H96, W144 × H72mm counter/timer

■ Features

- 36 input modes and 20 output modes
- Counting speed : 1cps/30cps/2kcps/5kcps
- Selectable voltage input(PNP) or No voltage input(NPN)
- Addition of Up/Down input mode
- Wide range of power supply
: 100-240VAC 50/60Hz, 12-24VAC/DC(Option)
- Selectable Counter/Timer by internal DIP switch
- Various time range
- Built-in Microprocessor



⚠ Please read "Caution for your safety" in operation manual before using.



■ Ordering information

FX	4	H	—	2P	
Item	Digit	Size	Output	Indicator	
				No mark	Single preset
				2P	Dual preset
				L	DIN W144×H72mm
				H	DIN W48×H96mm
				No mark	DIN W72×H72mm
	4				9999(4 digit)
	6				999999(6 digit)
				FX	Counter/Timer

■ Specifications

Model	Single preset		FX4	FX6	FX4H	—	—
	Dual preset		FX4-2P	FX6-2P	FX4H-2P	FX4L-2P	FX6L-2P
	Totalizer(Indicator)		FX4-I	FX6-I	FX4H-I	FX4L-I	FX6L-I
Digit			4 digit	6 digit	4 digit	4 digit	6 digit
Digit size			W8×H14mm	W4×H8mm	W6×H10mm	W8×H14mm	
Power supply	AC Voltage type		100-240VAC 50/60Hz				
	AC/DC Voltage type		12-24VAC 50/60Hz, 12-24VDC universal				
Allowable voltage range		90 to 110% of rated voltage					
Power consumption	AC Voltage type		• Indicator type: Approx. 6VA • Single preset: Approx. 7VA • Dual preset: Approx. 8VA(240VAC 50/60Hz)				
	AC/DC Voltage type		• Indicator type: Approx. 5.8VA • Single preset: Approx. 6.8VA • Dual preset: Approx. 7.6VA(240VAC 50/60Hz) • Indicator type: Approx. 2.7W • Single preset: Approx. 3.3W • Dual preset: Approx. 3.8W(24VDC)				
Max. counting speed for CP1, CP2		Selectable 1cps/30cps/2kcps/5kcps by internal DIP switch					
Min. input signal width	RESET input		Approx. 20ms				
	INHIBIT input						
Input	CP1, CP2 input (INHIBIT)		Input logic is selectable [Voltage input] Input impedance : 5.4kΩ, "H" level : 5-30VDC, "L" level : 0-2VDC [No-voltage input] Impedance at short-circuit : Max. 1kΩ, Residual voltage at short-circuit : Max. 2VDC, Impedance at open-circuit : Min. 100kΩ				
	RESET input						
One-shot output time		• Single preset type - 0.05 to 5sec. • Dual preset type - 1st. output 0.5sec. fixed, 2st. output : 0.05 to 5sec.					
Control output	Contact	Type	Single preset type : SPDT(1c), Dual preset type : 1st output SPDT(1c), 2nd output SPDT(1c)				
		Capacity	250VAC 3A at resistive load				
	Solid-state	Type	Single preset: 1 NPN open collector Dual preset: 1st output 1 NPN open collector, 2nd output 1 NPN open collector				
		Capacity	30VDC Max. 100mA Max.				
Memory protection		Approx. 10 years(When using non-volatile semiconductor memory)					
External sensor power		12VDC±10% 50mA Max.					
Environment	Ambient temperature		-10 to 55°C, storage: -25 to 65°C				
	Ambient humidity		35 to 85%RH, storage: 35 to 85%RH				
Insulation resistance		Min. 100MΩ(at 500VDC megger)					
Dielectric strength		2000VAC 50/60Hz for 1 minute					
Noise strength	AC power		±2kV the square wave noise(pulse width : 1μs) by the noise simulator				
	DC power		±500V the square wave noise(pulse width : 1μs) by the noise simulator				

Up/Down Counter/Timer

Specifications

Vibration	Mechanical	0.75mm amplitude at frequency of 10 to 55Hz(for 1 min.) in each of X, Y, Z directions for 1 hour				
	Malfunction	0.5mm amplitude at frequency of 10 to 55Hz(for 1 min.) in each of X, Y, Z directions for 10 minutes				
Shock	Mechanical	300m/s ² (approx. 30G) in each of X, Y, Z directions for 3 times				
	Malfunction	100m/s ² (approx. 10G) in each of X, Y, Z directions for 3 times				
Relay life cycle	Mechanical	Min. 10,000,000 operations				
	Electrical	Min. 100,000 operations at 250VAC 2A(resistive load)				
Approval		UL (Except for AC/DC power type)				
Weight ^{※1}		FX4 : Approx. 385g (approx. 249g) FX4-2P : Approx. 396g (approx. 258g) FX4-I : Approx. 353g (approx. 216g)	FX6 : Approx. 395g (approx. 259g) FX6-2P : Approx. 398g (approx. 262g) FX6-I : Approx. 351g (approx. 214g)	FX4H : Approx. 349g(approx. 234g) FX4H-2P : Approx. 375g(approx. 261g) FX4H-I : Approx. 321g(approx. 206g)	FX4L-2P : Approx. 651g (approx. 467g) FX4L-I : Approx. 593g (approx. 400g)	FX6L-2P : Approx. 678g (approx. 494g) FX6L-I : Approx. 586g (approx. 404g)

※1: This weight is with packaging and the weight in parentheses is only unit weight.

※ Environment resistance is rated at no freezing or condensation.

Connections

FX□-2P

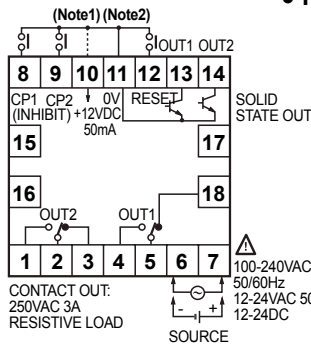

FX□

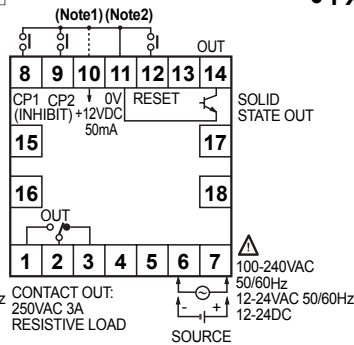

FX□-I

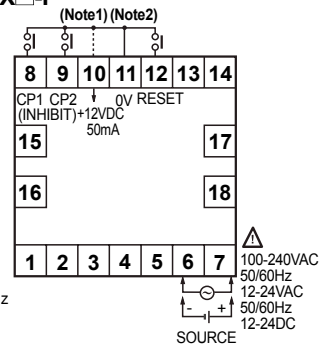

FX4H-2P

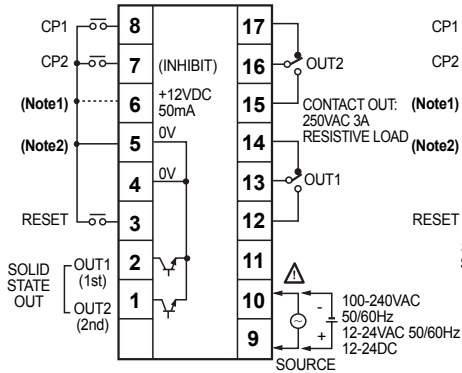

FX4H

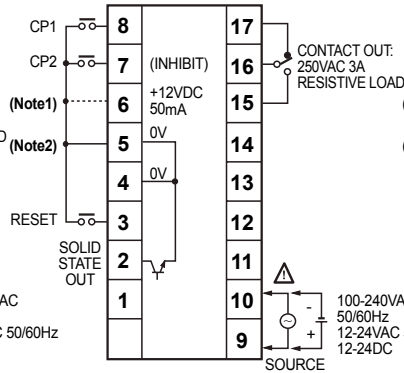

FX4H-I

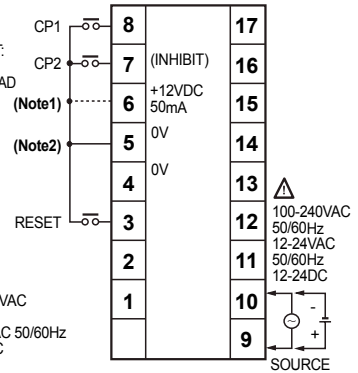

FX□L-2P

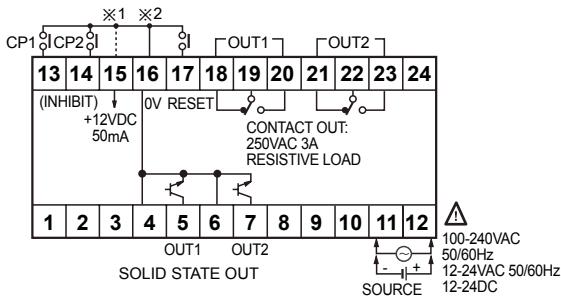

FX□L-I

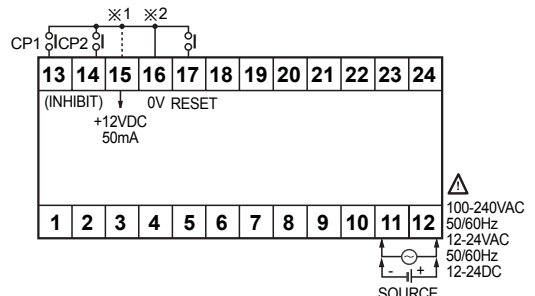

※ CP2(INHIBIT) : Time hold terminal when using for timer.
 ※ It is operated by power ON start type when using for timer.

※ 1. Connection for PNP input
 2. Connection for NPN input

(A)	Photo electric sensor
(B)	Fiber optic sensor
(C)	Door/Area sensor
(D)	Proximity sensor
(E)	Pressure sensor
(F)	Rotary encoder
(G)	Connector/Socket
(H)	Temp. controller
(I)	SSR/ Power controller
(J)	Counter
(K)	Timer
(L)	Panel meter
(M)	Tacho/ Speed/ Pulse meter
(N)	Display unit
(O)	Sensor controller
(P)	Switching mode power supply
(Q)	Stepper motor& Driver&Controller
(R)	Graphic/ Logic panel
(S)	Field network device
(T)	Software
(U)	Other

FX/FXH/FXL Series

Dimensions

FX Series

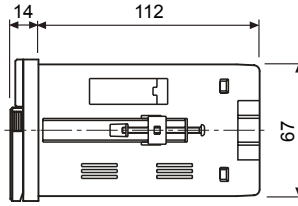
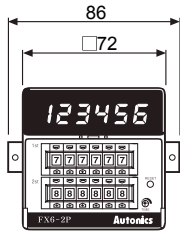

Panel cut-out

(unit: mm)

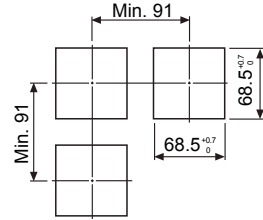

FXH Series

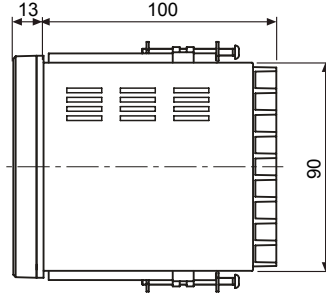
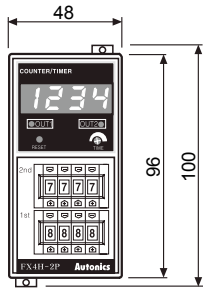

Panel cut-out

(unit: mm)

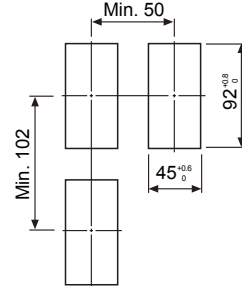

FXL Series

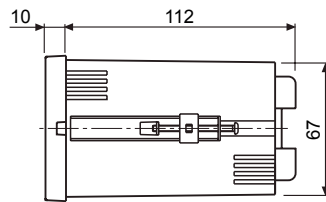
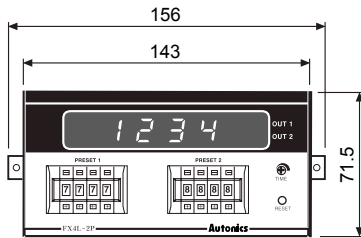

Panel cut-out

(unit: mm)

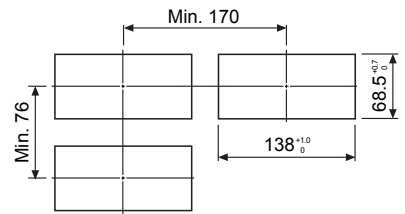

Input connections

No-voltage input(NPN)(Factory default)

Solid-state input(Standard sensor : NPN output type sensor)

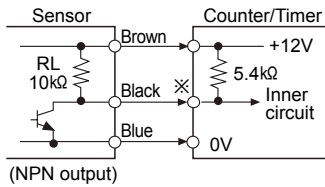

(NPN output)
※CP1, CP2(INHIBIT), RESET input

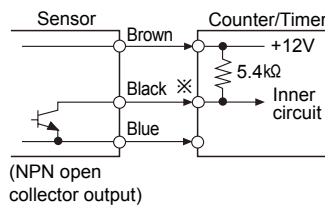

(NPN open collector output)

Contact input

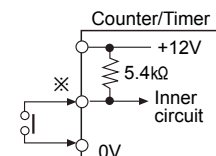

Counting speed :
1 or 30cps setting(Counter)

Voltage input(PNP)

Solid-state input(Standard sensor : PNP output type sensor)

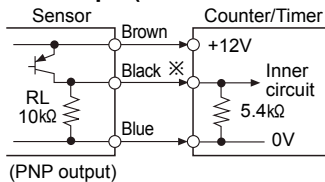

(PNP output)
※CP1, CP2(INHIBIT), RESET Input

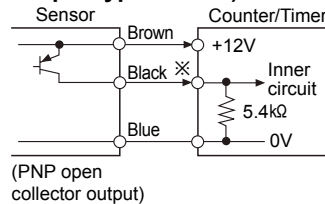

(PNP open collector output)

Contact input

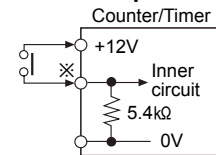

Counting speed :
1 or 30cps setting(Counter)

Up/Down Counter/Timer

Input logic selection

FX Series

Input logic is changeable by input logic selection switch located at the one-side of case.

- No-voltage input (NPN)
- Voltage input (PNP)

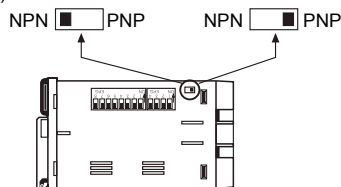

FXL Series

Input logic is changeable by input logic selection switch located at the terminal block.

- No-voltage input (NPN) (NPN) F S
- Voltage input (PNP) F S (PNP)

FXH Series

Input logic is changeable by input logic selection switch (SW3) located at inside of the case.

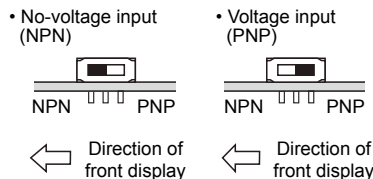

※Please be sure to turn power OFF before changing input logic.

Input & output connections

○ In case of operating the load by power supply of the sensor

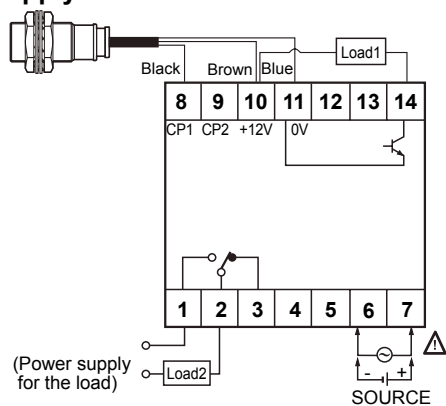

- Please select proper capacity of load, because total value of load capacity and current consumption should not be exceed current capacity. (Max. 50mA)

○ How to count by external power supply

This unit starts to count when "High" level(5-30VDC) is applied at CP1 or CP2 after selecting PNP.

○ In case of operating the load by external power supply

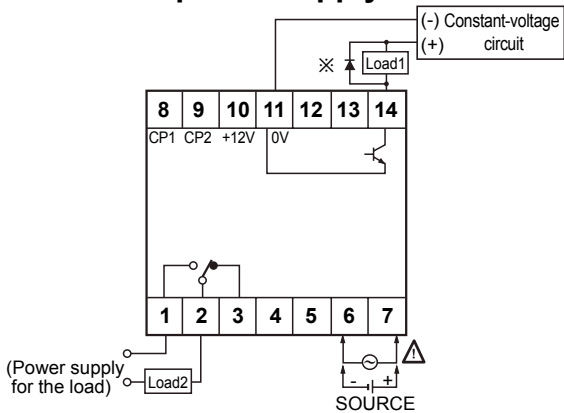

- The capacity of the load must not be exceed max. 30VDC, max. 100mA of the switching capacity of the transistor.
- Please do not supply the reverse polarity voltage.
- ※Please connector the surge absorber(Diode) at both terminals of the load, in case of using the inductive load. (Relay, etc.)

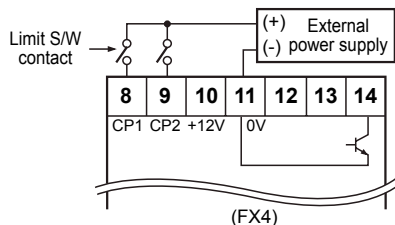

○ Using 2 counters with one sensor

Please connect as the power of sensor is supplied from only one of counters and design input logic with same way.

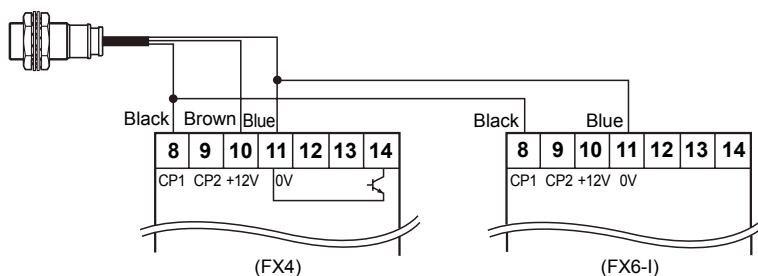

(A) Photo electric sensor

(B) Fiber optic sensor

(C) Door/Area sensor

(D) Proximity sensor

(E) Pressure sensor

(F) Rotary encoder

(G) Connector/Socket

(H) Temp. controller

(I) SSR/Power controller

(J) Counter

(K) Timer

(L) Panel meter

(M) Tacho/Speed/Pulse meter

(N) Display unit

(O) Sensor controller

(P) Switching mode power supply

(Q) Stepper motor& Driver&Controller

(R) Graphic/Logic panel

(S) Field network device

(T) Software

(U) Other

FX/FXH/FXL Series

■ Description of inner DIP switches

● FX Series

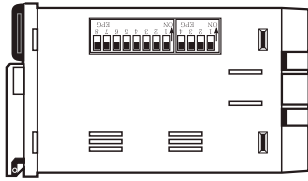

● FXH Series

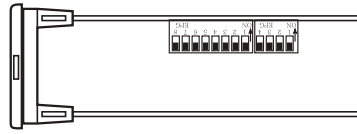

● FXL Series

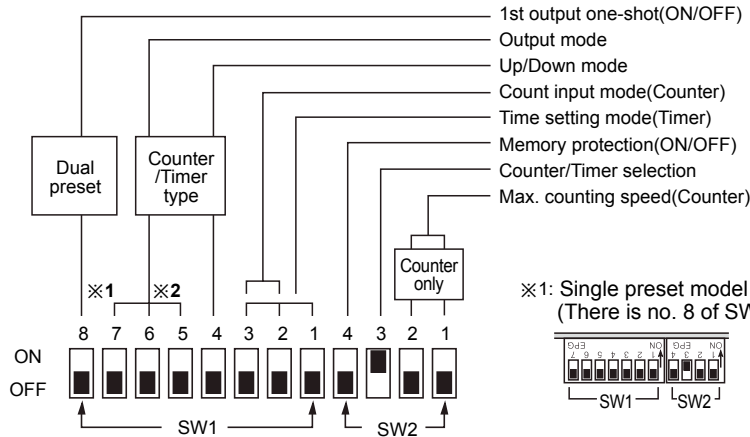
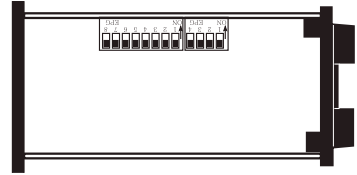

※1: Single preset model
(There is no. 8 of SW1)

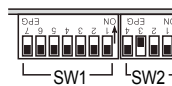

※2: Indication model
(There is no. 5, 6, 7, 8 of SW1)



● Max. counting speed

SW2	Functions
ON <input type="checkbox"/> OFF <input type="checkbox"/>	1cps
ON <input type="checkbox"/> OFF <input type="checkbox"/>	30cps
ON <input type="checkbox"/> OFF <input type="checkbox"/>	2kcps
ON <input type="checkbox"/> OFF <input type="checkbox"/>	5kcps

● Counter/Timer selection

SW2	Functions
ON <input type="checkbox"/> OFF <input type="checkbox"/>	Counter
ON <input type="checkbox"/> OFF <input type="checkbox"/>	Timer

● Memory protection

SW2	Functions
ON <input type="checkbox"/> OFF <input type="checkbox"/>	Disable the memory protection
ON <input type="checkbox"/> OFF <input type="checkbox"/>	Enable the memory protection

● Up/Down mode selection

SW1	Functions
ON <input type="checkbox"/> OFF <input type="checkbox"/>	Down mode
ON <input type="checkbox"/> OFF <input type="checkbox"/>	Up mode

● 1st output one-shot(ON/OFF)

SW1	Functions
ON <input type="checkbox"/> OFF <input type="checkbox"/>	1st output : One-shot output
ON <input type="checkbox"/> OFF <input type="checkbox"/>	1st output : Retained output

※This mode selects a one-shot output(0.5sec. fixed) or retained output(Until 2nd output turns off) for 1st output in the dual preset coounter.

※Example of F output operation mode

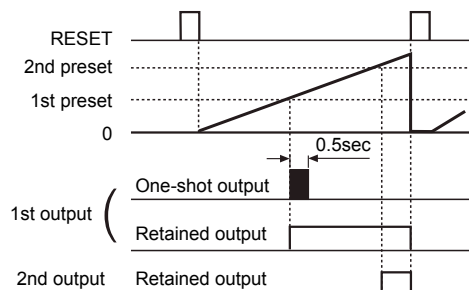

Up/Down Counter/Timer

Input operation(Counter)

Input mode		SW1	No-voltage input type(NPN)	Voltage input type(PNP)
Up mode	ON <input type="checkbox"/> 4 OFF <input checked="" type="checkbox"/> Up/Down-A (Command input)	ON <input type="checkbox"/> 2 3 OFF <input checked="" type="checkbox"/> <input checked="" type="checkbox"/>		
	Up/Down-B (Individual input)	ON <input type="checkbox"/> 2 3 OFF <input checked="" type="checkbox"/> <input checked="" type="checkbox"/>		
	Up/Down-C (Phase difference input)	ON <input type="checkbox"/> 2 3 OFF <input checked="" type="checkbox"/> <input checked="" type="checkbox"/>		
	Up (Count up input)	ON <input checked="" type="checkbox"/> 2 3 OFF <input type="checkbox"/> <input type="checkbox"/>		
Down mode	ON <input checked="" type="checkbox"/> 4 OFF <input type="checkbox"/> Up/Down-D (Command input)	ON <input type="checkbox"/> 2 3 OFF <input checked="" type="checkbox"/> <input checked="" type="checkbox"/>		
	Up/Down-E (Individual input)	ON <input type="checkbox"/> 2 3 OFF <input checked="" type="checkbox"/> <input checked="" type="checkbox"/>		
	Up/Down-F (Phase difference input)	ON <input type="checkbox"/> 2 3 OFF <input checked="" type="checkbox"/> <input checked="" type="checkbox"/>		
	Down (Count down input)	ON <input checked="" type="checkbox"/> 2 3 OFF <input type="checkbox"/> <input type="checkbox"/>		

※(A): Over min. signal width, (B): Over 1/2 of min. signal width.

If the signal width of (A) or (B) is less than min. signal width, ±1 of count error is occurred.

(A) Photo electric sensor
(B) Fiber optic sensor
(C) Door/Area sensor
(D) Proximity sensor
(E) Pressure sensor
(F) Rotary encoder
(G) Connector/Socket
(H) Temp. controller
(I) SSR/ Power controller
(J) Counter
(K) Timer
(L) Panel meter
(M) Tacho/ Speed/ Pulse meter
(N) Display unit
(O) Sensor controller
(P) Switching mode power supply
(Q) Stepper motor& Driver&Controller
(R) Graphic/ Logic panel
(S) Field network device
(T) Software
(U) Other

FX/FXH/FXL Series

Time setting mode(Timer)

SW1	4digit	6digit
A	ON: 1 2 3 OFF: [][] [][] 99.99sec	99999.9sec
B	ON: 1 2 3 OFF: [][] [][] 999.9sec	999999sec
C	ON: 1 2 3 OFF: [][] [][] 9999sec	99min 59.99sec
D	ON: 1 2 3 OFF: [][] [][] 99min 59sec	999min 59.9sec
E	ON: 1 2 3 OFF: [][] [][] 999.9min	9999.9min
F	ON: 1 2 3 OFF: [][] [][] 99hour 59min	99hour 59min 59sec
G	ON: 1 2 3 OFF: [][] [][] 999.9hour	9999hour 59min
H	ON: 1 2 3 OFF: [][] [][] 9999hour	99999.9hour

Counting operation of indication type(Counter)

Up mode

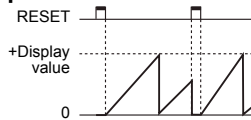

Up / Down-A, B, C mode

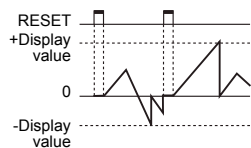

Down mode

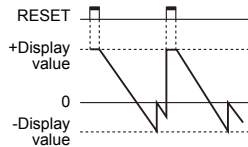

Up / Down-D, E, F mode

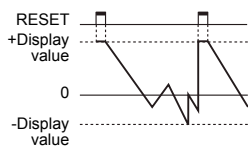

Time operation of indication type (Timer)

Up mode

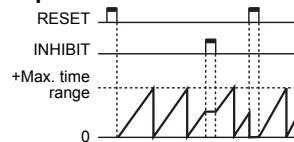

Down mode

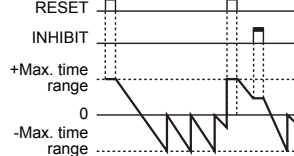

Setting function of Decimal point

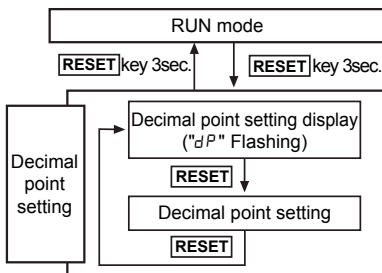

- ✗ It advances to "Decimal point setting mode" if press RESET key for 3sec.
- ✗ It returns to RUN mode by press RESET key for 3sec in "Decimal point setting mode".
- ✗ It returns to RUN mode if no RESET button or digital switch(Dual-setting digital switch for dual preset type) is applied for 60sec. in the "Decimal point setting mode".
- ✗ The decimal point setting does not exist in indicator.

Decimal point setting

- The decimal point setting of 6digits indicator

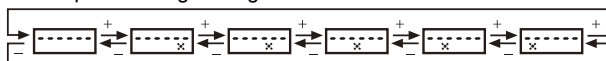

- The decimal point setting of 4digits indicator

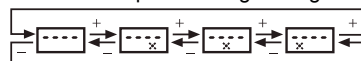

- ✗ Existing decimal point setting is displayed when entering into decimal point setting mode.
- ✗ If pressing one of digital switch(2nd preset type: 2nd preset digital switch) Up(+) buttons in decimal point setting mode, decimal point will be moved to Up(+) direction.
- ✗ If pressing one of digital switch(2nd preset type: 2nd preset digital switch) Down(-) buttons, decimal point will be moved to Down(-) direction.

Up/Down Counter/Timer

Output operation mode

One-shot output (0.05 to 5sec.) of 2nd output Retained output One-shot output (0.5sec.) of 1st output Retained output

※The output of single preset type is operated at the status of the second output mode

Output mode (SW1)	4 ON OFF Up mode		4 ON OFF Down mode		Operation after count up
	Up, Up / Down-A, B, C		Down, Up / Down-D, E, F		
F					The display value continues until Reset signal applied and the output is held. <ul style="list-style-type: none"> • 1st retained output and 2nd output are maintained until Reset signal is applied. • When using 1st output as one-shot output, it will return after operating for 0.5sec.
N					The display value and output will be held until Reset input is applied.
C					The display value will be Reset Start status as soon as it reaches to 2nd setting value. <ul style="list-style-type: none"> • 1st retained output will be OFF after 2nd one-shot output. • 1st one-shot output will be reset after operating 0.5sec., and it is not related to 2nd output.
R					Display value will be maintained until 2nd output is Off, then it will be reset. <ul style="list-style-type: none"> • 1st retained output will be OFF after 2nd one-shot output. • 1st one-shot output will be reset after operating 0.5sec., and it is not related to 2nd output.
K					The display value continues until Reset signal applied. <ul style="list-style-type: none"> • 1st retained output will be OFF after 2nd one-shot output. • 1st one-shot output will be reset after operating 0.5sec., and it is not related to 2nd output.
P					The display value will be Reset Start status as soon as it reaches to 2nd setting value. <ul style="list-style-type: none"> • 1st retained output will be OFF after 2nd one-shot output. • 1st one-shot output will be reset after operating 0.5sec., and it is not related to 2nd output.
Q					The display continues until 2nd output is OFF. <ul style="list-style-type: none"> • 1st retained output will be OFF after 2nd one-shot output. • 1st one-shot output will be reset after operating 0.5sec. not related to 2nd output.
S	Up		Down		<ul style="list-style-type: none"> • Up, Up/Down-A, B, C input mode <ul style="list-style-type: none"> - OUT1 is ON when (Display value) ≥ (1st setting value) - OUT2 is ON when (Display value) ≥ (Dual setting value) • Down, Up/Down-D, E, F input mode <ul style="list-style-type: none"> - OUT1 is ON when (Display value) ≤ (1st setting value) - OUT2 is ON when (Display value) ≤ (Zero)
Counter ON OFF 5 6 7					
	Up / Down-A, B, C		Up / Down-D, E, F		
S					When it is used as Timer, 1st output and 2nd output are flashing repeatedly.

※One-shot output time is set by front TIME adjuster.

- (A) Photo electric sensor
- (B) Fiber optic sensor
- (C) Door/Area sensor
- (D) Proximity sensor
- (E) Pressure sensor
- (F) Rotary encoder
- (G) Connector/Socket
- (H) Temp. controller
- (I) SSR/Power controller
- (J) Counter
- (K) Timer
- (L) Panel meter
- (M) Tacho/Speed/ Pulse meter
- (N) Display unit
- (O) Sensor controller
- (P) Switching mode power supply
- (Q) Stepper motor& Driver&Controller
- (R) Graphic/Logic panel
- (S) Field network device
- (T) Software
- (U) Other

FX/FXH/FXL Series

■ Proper usage

○ Reset

● Reset

In case of changing the input mode after supplying the power, please provide an external reset or manual reset. If reset is not executed, the counter will be working in previous mode.

● Reset signal width

To guarantee proper reset, the signal must be supplied for a minimum of min. 20ms regardless the signal comes from a contact or a solid-state input.

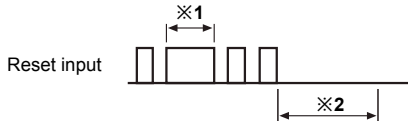

※1: In case of a contact reset, contact chattering will not affect the reset as long as it is applied for a minimum of 20ms.

※2: Input signal at CP1 & CP2 must be applied for a minimum of 50ms after the reset is removed.

○ Mini. count signal width

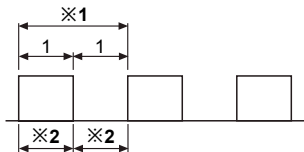

※1: Please make duty ratio(ON/OFF) as 1:1.

※2: Min. signal width
 1cps : Min. 500ms
 30cps : Min. 16.7ms
 2kcps : Min. 0.25ms
 5kcps : Min. 0.1ms

○ Max. counting speed

This is a response speed per 1 sec. when the duty ratio (ON:OFF) of input signal is 1:1. If the duty ratio is not 1:1, the width between ON and OFF should be over min. signal width and the response speed will getting slower against input signal. If either ON or OFF signal is shorter than minimum signal width, this product may not respond.

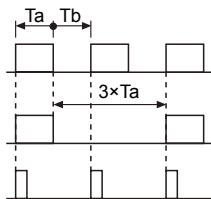

Ta(ON width) and Tb(OFF width) needed to be over min.signal width.

Max. counting speed is 1/2 value of rated spec. when duty ratio is 1:3.

It can not respond if it is smaller than min. signal width(Ta).

○ Power

The inner circuit voltage starts to rise up for the first 100ms after power on, the input may not work at this time. And also the inner circuit voltage drops down for the last 500ms after power off, the input may not work at this time.

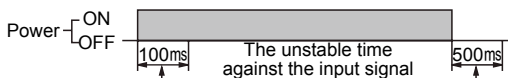

○ INHIBIT(For timer)

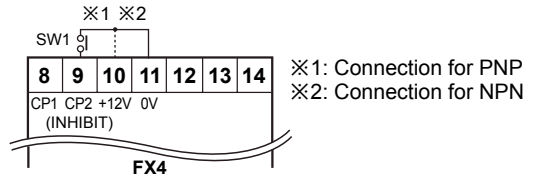

- INHIBIT mode is active when SW1 turns ON. (Time Hold)
- When power is applied, it starts to progress and INHIBIT mode is used to stop the time is under the progress at the moment.
- When SW1 is OFF, timer starts to progress again.

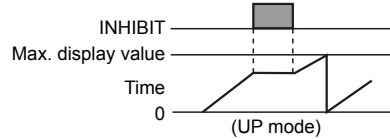

○ How to use the sticker

The below sticker can be found inside the box. Use the sticker according to application as follow;

Ex1) Measurement of length by the rotary encoder EX2) Timer[F mode] the rotary encoder

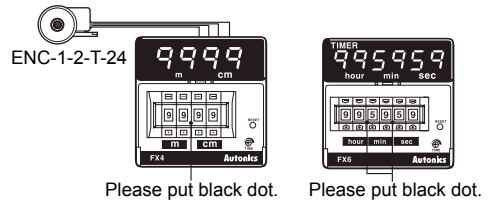

○ Error display

Error signal	Error description	Returning method
Err0	When 2nd setting value is 0	Change the setting value to non zero status
	When 2nd setting value is smaller than 1st setting value	Make 2nd setting value bigger than 1st setting value

- ※There is no Error display function in indication type.
- ※There is no Error function in indicator.
- ※When Error is display, the OUTPUT continues OFF state.
- ※1st output maintains OFF status by 1st setting value as 0.

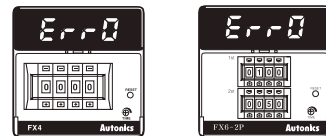

○ Case & DIP switch detachment

● FXH Series

- ① Push down the front guide.
- ② Pull out the front guide.

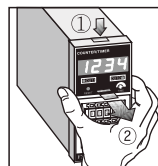

● FXL Series



Unscrew the rear bolt, and pull the body backward.



※Please be careful of the injury caused by tools.